



INSTALLATION MANUAL
TOYOTA TUNDRA MATRIX FRONT BUMPER
PRODUCT NUMBER: X545X
APPLICATION: 2022 TOYOTA TUNDRA



IMPORTANT SAFETY GUIDE | Your safety and the safety of others is very important.

In order to help you make informed decisions about safety, we have provided the following warnings, safety precautions, installation instructions, and other important information to alert you to potential hazards that could hurt you or others.

Please do a job safety analysis before each task to identify potential hazards for your situation and remove/protect against them. Use own good judgment and take your time.

Check packaged materials immediately upon arrival to ensure that all listed parts are included and undamaged.

Read and understand all warnings, safety precautions, and instructions before installing this product.

SENSORS FIELD OF VIEW MAY BE ALTERED WITH USE OF THE REPLACEMENT BUMPER.

WARNINGS

- Failure to observe the following warnings and instructions provided in this manual could lead to severe injury and/or death.
- For professional installation only. Careless installation and/or operation can result in serious injury, death, and/or equipment damage. All liability for installation and use rests with the user or consumer.
- Fab Fours, Inc. only approves installing this product according to these written instructions with the hardware provided. Failure to install according to these instructions will invalidate the warranty. This includes, but is not limited to, using alternative installation methods, hardware, or materials.
- This product is for off road use only.

SAFETY PRECAUTIONS

- Always remove jewelry and wear eye protection.
- Always use extreme caution when jacking up a vehicle for work. Set emergency brake and use tire blocks. Locate and use the vehicle manufacturers designated lifting points. Use jack stands.
- Always use appropriate and adequate care in lifting components into place.
- Always ensure components will remain secure during installation and operation.
- Always wear safety glasses when installing this kit. A drilling operation will cause flying metal chips. Flying chips can cause serious eye injury.
- Always use extreme caution when drilling a vehicle. Always disconnect power before welding. Thoroughly inspect the area to be drilled (on both sides of material when possible) prior to drilling, and relocate any objects that may be damaged.
- Always use extreme caution when welding a vehicle. Thoroughly inspect the area to be welded (on both sides of material when possible) prior to welding, and relocate any objects that may be a fire hazard. When welding in a cab, make sure the interior surfaces are covered (e.g., welding blanket) and a fire extinguisher is at hand.
- Always use extreme caution when cutting and trimming during fitting.
- Always tighten all nuts and bolts securely per installation instructions.
- Always route electrical cables carefully. Avoid moving parts, components that become hot, and rough or sharp edges.
- Always insulate and protect all exposed wiring and electrical terminals.
- Perform regular inspections and maintenance on mounts and hardware.

TABLE OF CONTENTS

2	SAFETY / DISCLAIMER
3	TABLE OF CONTENTS
4	A MESSAGE FROM THE OWNER
5	GETTING STARTED
6	PROVIDED MATERIAL
7	DISASSEMBLY
9	INSTALLATION
28	CONTACT

A MESSAGE FROM THE OWNER



Fab Fours' was born out of a passion for customizing vehicles and a love of the outdoors. Our engineering team uses the latest 3D design software to turn new product ideas into reality. In our factory, designs come to life with the combination of cutting edge technology for metal cutting and forming and an American workforce that puts its' heart and pride into every product.

From design and manufacturing, to quality and delivery, Fab Fours' mission is to be the market leader for steel truck and jeep accessories. We make sure a quality product is delivered on time, more than expected, better than expected to our customers.

Enjoy your new Fab Fours product. Welcome to the family!

Greg Higgs

FOUNDER, FAB FOURS

GETTING STARTED

Before you begin the installation process of your new Fab Fours product, we suggest laying out all materials and parts on a pad or protective surface.

Failure to fully account for all components before beginning installation may leave vehicle immobile until part is acquired. Refer to the next pages as an inventory check.

PROVIDED MATERIALS

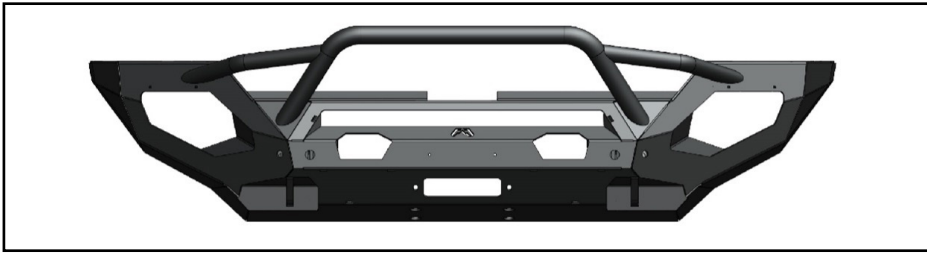

22606 - BUMPER SHELL

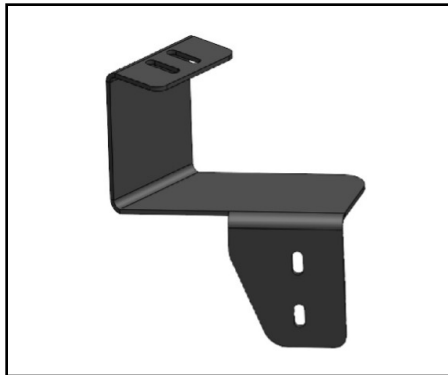

22610 - AIR DAM
RELOCATION BRACKET



22352 - LIGHT BAR
L-BRACKETS QTY:2

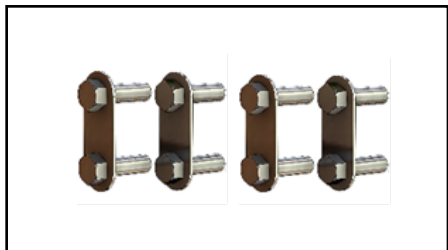

20296 - BOLT STRIP QTY:4

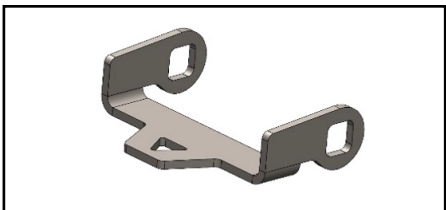

22840 - AIR DAM MOTOR
ARM REPLACEMENT



22607 - DS MOUNTING
BRACKET



22608 - PS MOUNTING
BRACKET

22611 -
AIR DAM MOTOR
RELOCATION
BRACKET

X545X-IM -
X5451-52
INSTRUCTION
MANUAL

61632 -
EPOXY QTY:2

50314-HW -
HARDWARE
KIT

TOOLS REQUIRED

- Panel pry tool
- Painter's tape
- Duct tape
- RTV sealant
- Measuring tool
- Cutting tool (For cutting thick plastic)
- Phillips head screwdriver
- Knife
- 7mm socket wrench
- 10mm socket wrench
- 17mm combination wrench
- 3/8" socket wrench
- 7/16" socket wrench
- 1/2" socket wrench
- 5/8" combination wrench
- 11/16" socket wrench
- 3/4" combination wrench

Recommended: 1/4" wire loom and electrical tape

ASSISTANCE

We recommend two people perform the installation as items are heavy and may need to be held in place while installing.

ORGANIZATION

Disassemble the vehicle where you can catalog and store everything. We suggest labeling and bagging all the OEM bolts when removing from the vehicle. Failure to keep track of parts could lead to an inability to properly reinstall components.

ASSISTANCE

This manual shows the six sensor configuration for illustration purposes but your specific installation may vary.

HARDWARE KIT | X545X-IM

FAB FOURS IDENTIFICATION	COMPONENT DESCRIPTION	QTY
50314-HW	1/2 USS Flat Washer Grade 8 Z&Y	8
50314-HW	1/2", SAE, Yellow-zinc, Grade 8, Lock washer	8
50314-HW	1/2"-13, Yellow-zinc, Grade 8, Hex nut	8
50314-HW	1/4"-20 x 1", Yellow-zinc, Grade 8, Hex head cap screw	6
50314-HW	1/4"-20, Yellow-zinc, Grade 8, Hex nut	6
50314-HW	1/4", Yellow-zinc, Grade 8, Lock washer	6
50314-HW	1/4", Yellow-zinc, Grade 8, Flat washer	12
50314-HW	7/16"-14 x 1.25", Yellow-Zinc, Grade 8, Hex head cap screw	6
50314-HW	7/16"-14", Yellow-Zinc, Grade 8, Hex nut	4
50314-HW	7/16", Yellow-Zinc, Grade 8, Lock washer	6
50314-HW	7/16" USS, Yellow-Zinc, Grade 8, Flat washer	10
50314-HW	1" Plastic sensor hole plug	2
50314-HW	3/4" Plastic sensor hole plug	2

1. Use 3/4" masking tape to create a cutting line on the front valance. Use the outer body line to line up the lower portion of the tape. Figure 1-2.

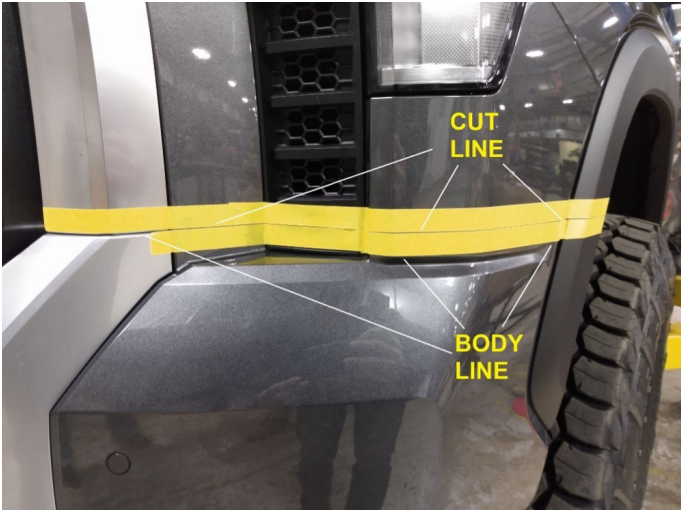

Figure 1

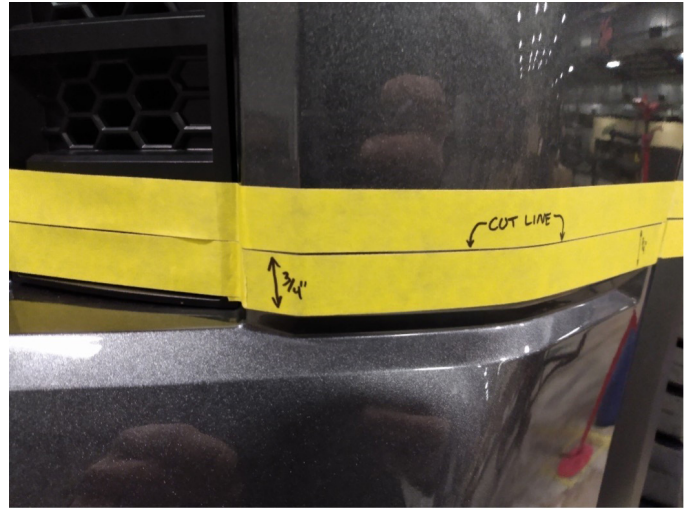

Figure 2

2. Line the tape from the grill bodyline to the valance measure at a measurement of 7/8" from the flat face in front of the mesh trim insert. Figure 3.



Figure 3

3. Use a knife to cut the tape on either side of the mesh trim insert. Carefully use a body pry tool to separate the mesh from the front valance. Figure 4.



Figure 4

4. Once the tape cutting line is in place, carefully use a cutting tool of choice to cut along the line all the way through the fender flare. Figure 5.



Figure 5

5. Use the cutting tool to cut the mesh insert. Figure 6.



Figure 6

6. Use a 10mm socket to remove the four (4) bolts holding the top of the grille to the core support (Figure 7.). Use a body pry tool to remove the two (2) push pins on the sides of the top grill and unplug the wiring harness (Figure 8.).



Figure 7



Figure 8

7. Use a 10mm socket to remove the four (4) bolts on the front of the wheel wells to access the valance body clips. Figure 9.



Figure 9

8. Carefully use a body pry tool to disengage the panel clips holding the fender flare onto the truck. Pull the flare away from the body to access the valance clips. Note: It is NOT required to fully remove fender flare. Figure 10.



Figure 10

9. Use a 10mm socket to remove the four (4) bolts holding the bottom of the bumper to the frame structure. Figure 11.



Figure 11

10. Remove the grill and bumper assembly from the truck by carefully disengaging the lower grille panel clips. Set the grill assembly aside for disassembly.

11. Use a 17mm socket to remove the eight (8) bolts (two (2) on top, two (2) on bottom) holding the crash bar to the frame rails. Figure 12-13.



Figure 12

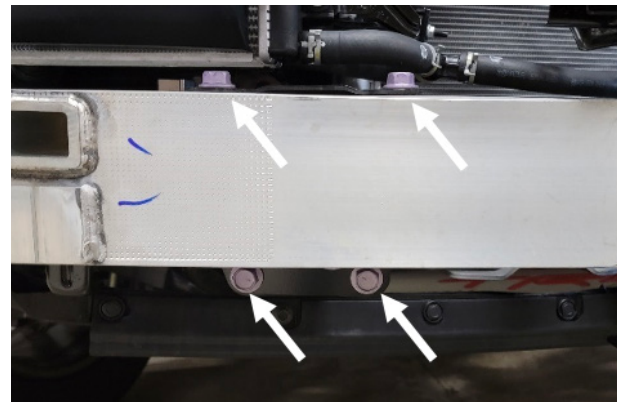

Figure 13

12. Start disassembling the grille by remove the sensors and sensor housings form the bumper. remove the sensor from the housing by disengaging the top clips and carefully pulling the sensor out. Figure 14.

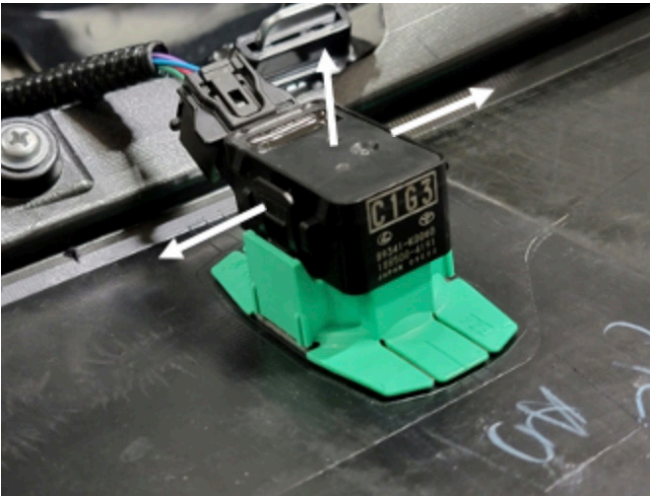

Figure 14

13. Use a Phillips head screw to remove the four (4) bolts holding the lower bumper pieces onto the grille assembly. Figure 15.



Figure 15

14. Remove the lower grille cover (Figure 16) by removing two (2) Phillips head screws and disengaging seven (7) body clips. Figure 16-18.



Figure 16



Figure 17



Figure 18

15. Remove the fog light cover panel (Figure 19) by disengaging the 17 body clips. Figure 19-20.



Figure 19

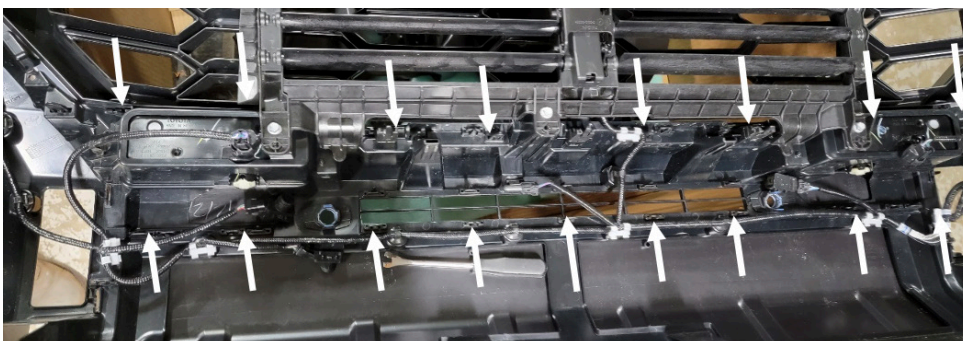

Figure 20

16. Use a Phillips head screwdriver to remove the two (2) bolts holding the fog lights to the grille assembly. Figure 21.



Figure 21

17. Use a body pry tool to remove the wiring harness from the lower bumper. Note: Leave the harness attached to the grille. Figure 22.

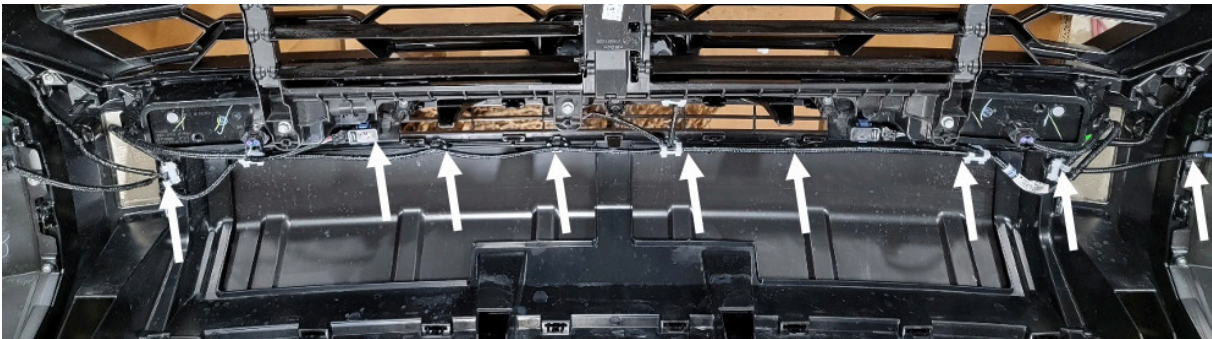

Figure 22

18. Cut the lower portion of the grille off using the lines shown in Figure 23-24.



Figure 23



Figure 24

19. Reinstall the grille assembly by reversing steps 6-8. Figure 25.



Figure 25

20. Remove the sensor housing from the OEM bumper by carefully using a pry tool or razor blade to separate the 3M adhesive from the shell. Figure 26.

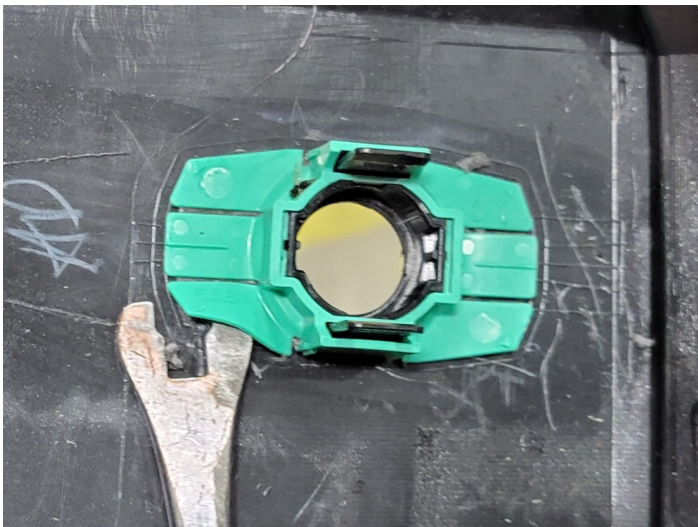

Figure 26

21. Use a Phillips head screwdriver to remove the bolts on the air dam housing. Figure 27.



Figure 27

22. Use a 10mm socket and a Phillips head to remove the 2 hex head bolts and 1 screw respectively. Remove the motor assembly from the housing. Remove the motor assembly from the aluminum crash bar using a 10mm socket to remove the 4 bolts. Figure 28.

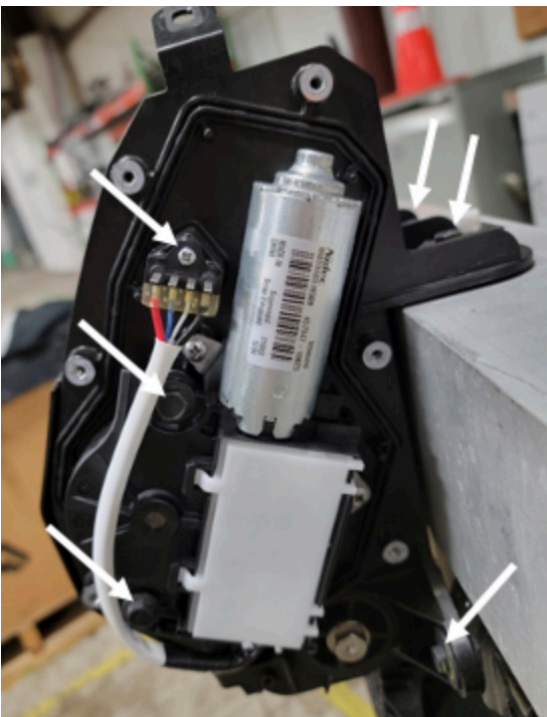

Figure 28

23. Remove the white plastic gear from the motor assembly by pulling it off. Figure 29.

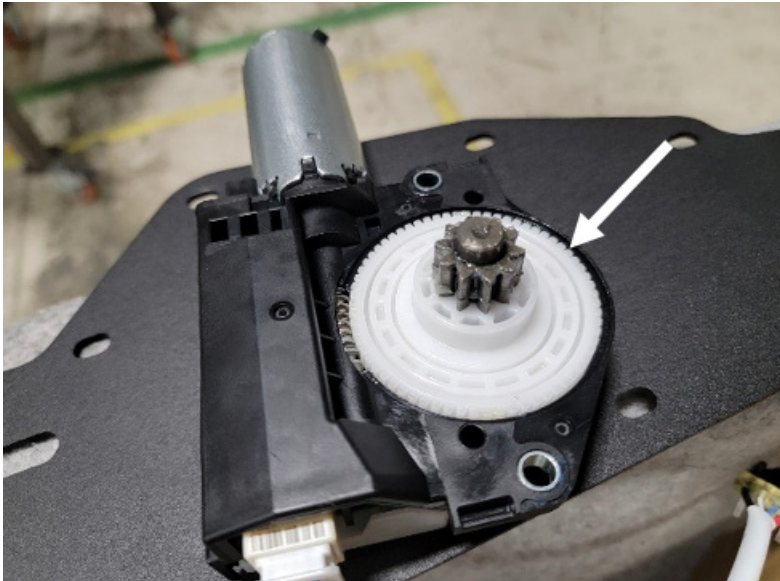

Figure 29

24. Use a Phillips head to remove the 3x bolts holding the gear and shaft in place. Remove the gear and shaft from the assembly. Figure 30-31.

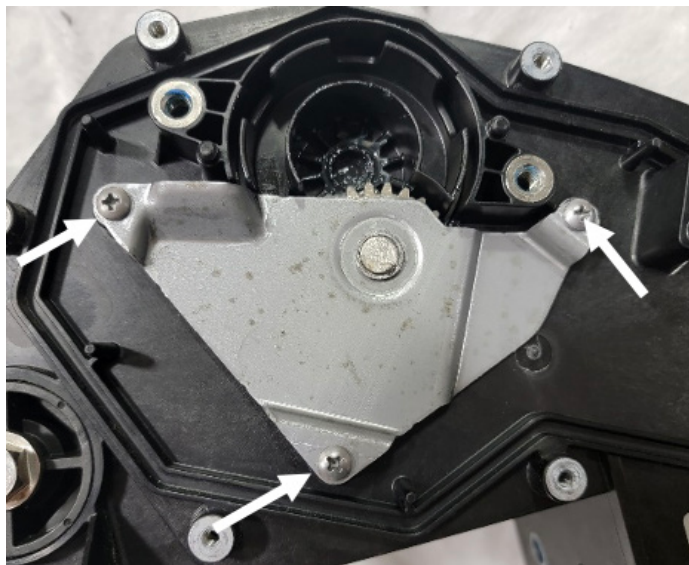

Figure 30

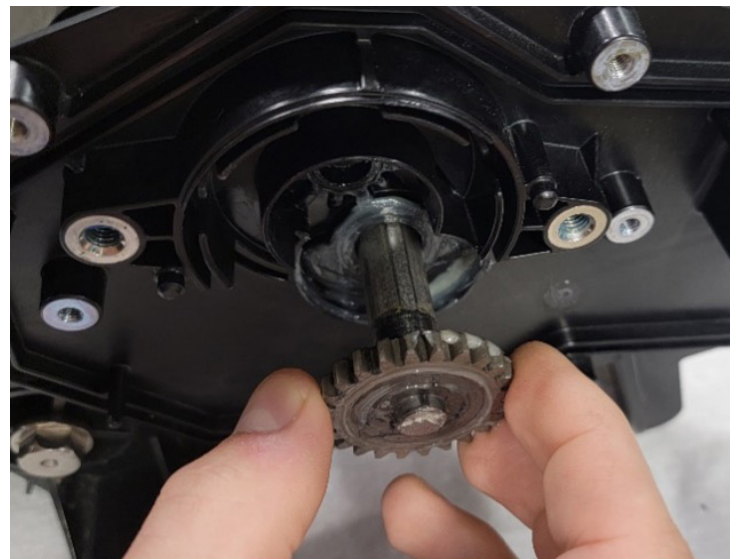

Figure 31

25. Remove the E-clip from the linkage pin. Set the gear shaft linkage aside for later assembly. Figure 32.



Figure 32

26. Use a cutting too to remove the access gusset material on the air dam motor housing. Figure 33-37.



Figure 33



Figure 34

Figures continued on next page

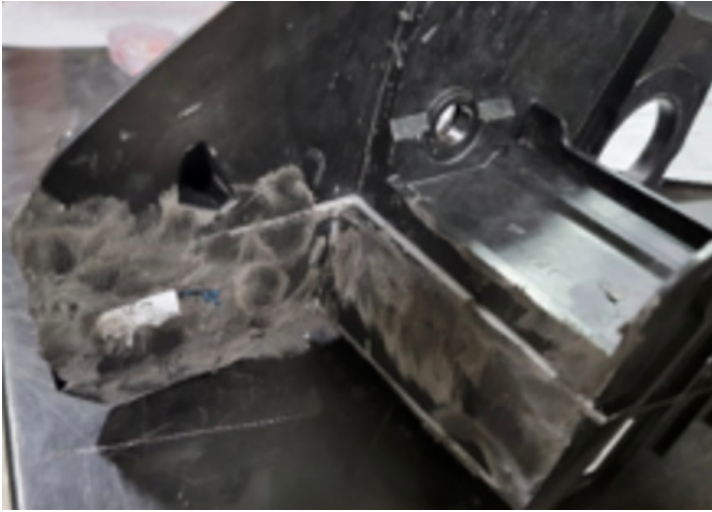

Figure 35

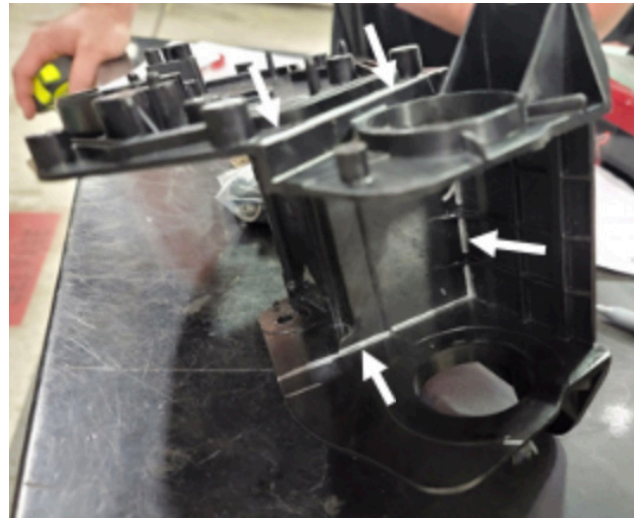

Figure 36



Figure 37

27. Begin reassembling motor by replacing arm linkage (removed in step 24) with arm replacement 22840. Figure 38.



Figure 38

28. Reverse steps 20-23 to put the motor assembly back together. Include the shaft linkage removed in step 24.

29. Use a 1/4" drill bit to drill 2 holes in the motor assembly to attach it to the provided mounting bracket (22610). Use the provided 1/4" yellow zinc bolts with washers and nuts. Figure 39.



Figure 39

30. Use a 12mm and 10mm socket to relocate the passenger side horn to the 10mm bolt. This will allow room for the air dam relocation. Figure 40-41.

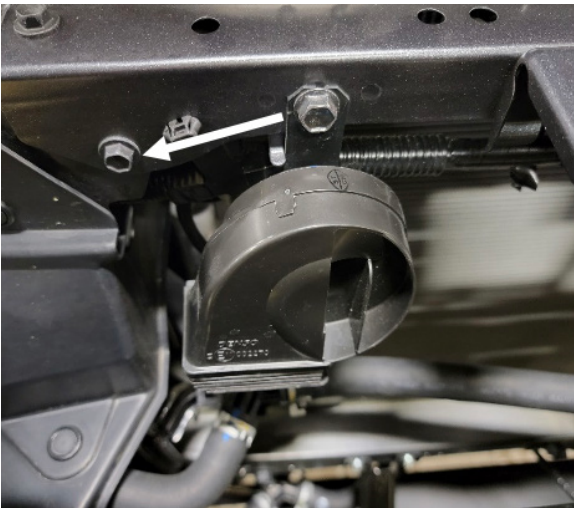

Figure 40

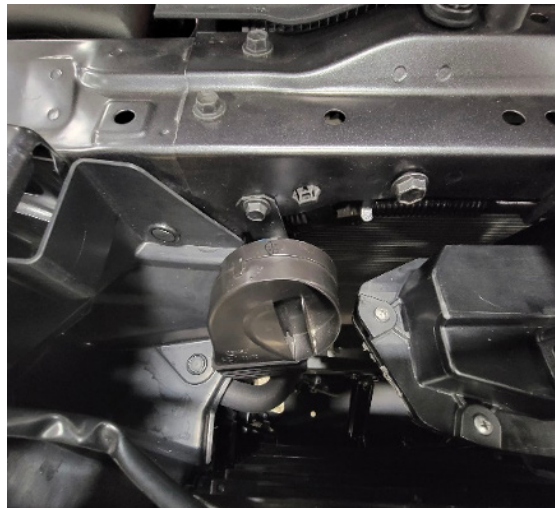

Figure 41

31. Use the provided ¼" yellow zinc bolts with washers and nuts to attach the air dam relocation bracket to the grill mounts. Plug in the air dam motor to its harness. Figure 42.

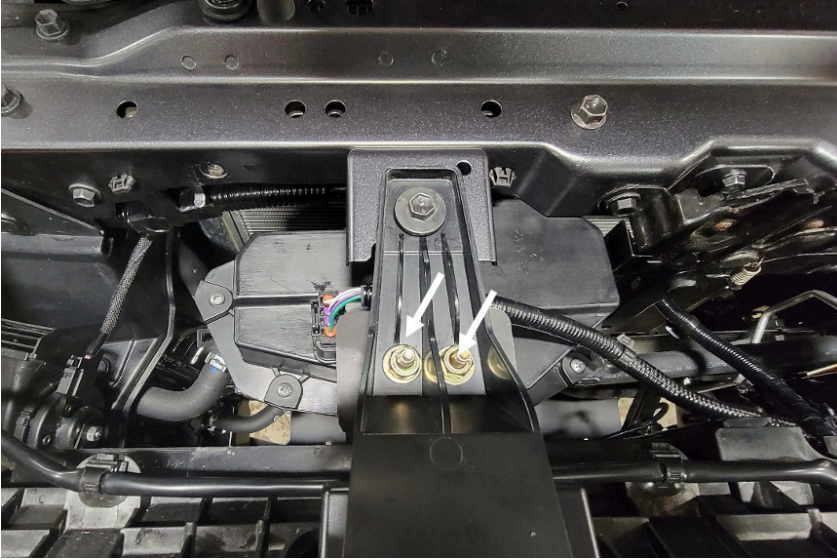

Figure 42

32. Use the provided epoxy packets to attach the sensor housings into your Fab Fours bumper. Place a small dap of epoxy under both corners of the housings and press it into the shell. Use duct tape to hold it in place until the epoxy is dry. Figure 43. The housings should be reinstalled in the same orientation that they were removed. All sensors connectors should face away from the winch.

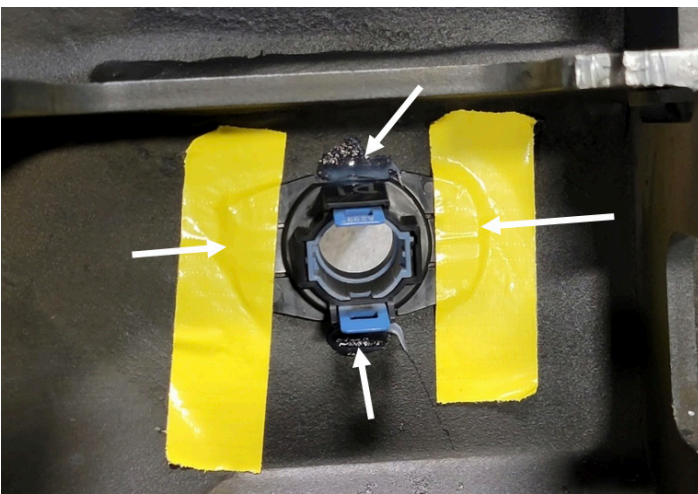

Figure 43

33. If installing a light bar: Use the provided L brackets (22352) along with 2x 1/4" bolts with washers and nuts to position the light bar in place. Figure 44.



Figure 44

34. If installing a winch: do so now per the winch manufactures recommendations. Note: The control box will need to be relocated as it will not clear the grille. Figure 45.



Figure 45

35. Using one (1) of the provided 7/16" bolts, lock and flat washers loosely install the provided intermediate bracket (part# 22607) into the driver's side frame end. Figure 46. Repeat on the passenger's side with the provide bracket (part# 22608).



Figure 46

36. Reusing the OEM hardware removed earlier, reinstall the two (2) OEM fasteners into the lower two (2) holes in the intermediate brackets (part# 22607 & 22608) Figure 47.



Figure 47

37. Install two (2) of the provided 7/16" bolts, lock washers, flat washers, and nuts into the upper two (2) holes in the intermediate brackets (part# 22607 & 22608) Figure 48.



Figure 48

38. Using a 17mm combination wrench, tighten the previously installed OEM fasteners. Using a 5/8" combination wrench and 11/16" socket wrench, tighten the previously installed 7/16" hardware.

39. Remove the tape and wire loom on the sensor wiring harness to separate the sensor wires from the rest of the harness. Figure 49 & 50 It is advised but not required to source new wire loom to protect the sensor wires that were removed from the OEM wire loom.



Figure 49

Figures continued on next page

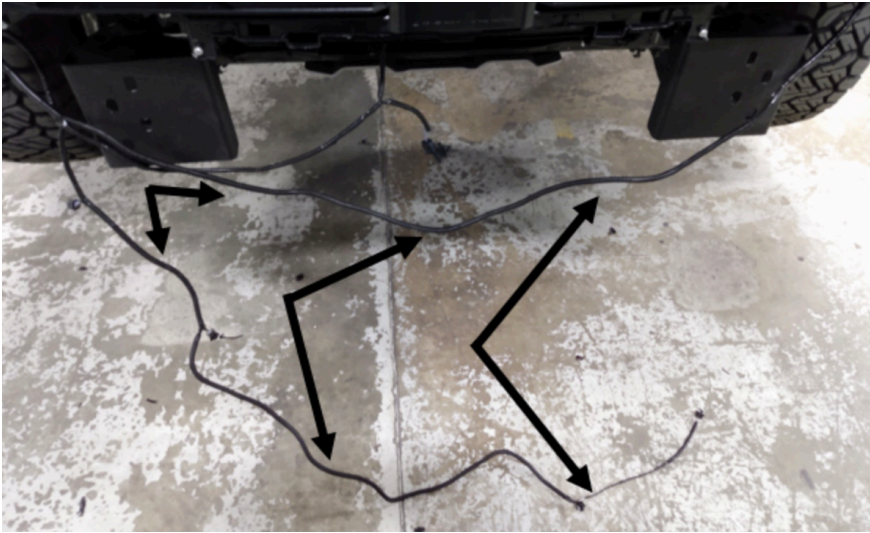

Figure 50

40. Using the four (4) provided strips and eight (8) 1/2" flat washers, lock washers, and nuts install the bumper to the intermediate brackets. Figure 51.

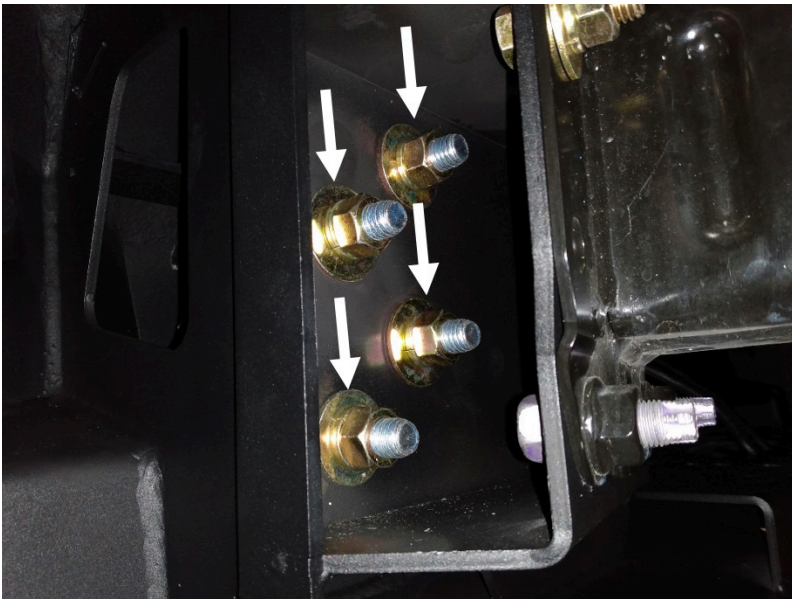

Figure 51

41. After aligning the bumper with the vehicle, use a 3/4" socket wrench to tighten the previously installed 1/2" hardware. Figure 52.



Figure 52

INSTALLATION COMPLETE

CONTACT INFORMATION

**FAB FOURS INC.
2213 INDUSTRIAL PARK ROAD
LANCASTER, SC 29720**

PHONE: (866) 385-1905

FAX: 970-385-1914

EMAIL: SUPPORT@FABFOURS.COM

FABFOURS.COM



**“IF YOU’RE LOOKING FOR MORE OF THE SAME,
THEN YOU’VE COME TO THE WRONG PLACE.”**

- GREG HIGGS

