



INSTALLATION MANUAL
TOYOTA TUNDRA VENGEANCE FRONT BUMPER
PRODUCT NUMBER: D545X-IM
APPLICATION: 2022 TOYOTA TUNDRA



IMPORTANT SAFETY GUIDE | Your safety and the safety of others is very important.

In order to help you make informed decisions about safety, we have provided the following warnings, safety precautions, installation instructions, and other important information to alert you to potential hazards that could hurt you or others.

Please do a job safety analysis before each task to identify potential hazards for your situation and remove/protect against them. Use own good judgment and take your time.

Check packaged materials immediately upon arrival to ensure that all listed parts are included and undamaged.

Read and understand all warnings, safety precautions, and instructions before installing this product.

SENSORS FIELD OF VIEW MAY BE ALTERED WITH USE OF THE REPLACEMENT BUMPER.

WARNINGS

- Failure to observe the following warnings and instructions provided in this manual could lead to severe injury and/or death.
- For professional installation only. Careless installation and/or operation can result in serious injury, death, and/or equipment damage. All liability for installation and use rests with the user or consumer.
- Fab Fours, Inc. only approves installing this product according to these written instructions with the hardware provided. Failure to install according to these instructions will invalidate the warranty. This includes, but is not limited to, using alternative installation methods, hardware, or materials.
- This product is for off road use only.

SAFETY PRECAUTIONS

- Always remove jewelry and wear eye protection.
- Always use extreme caution when jacking up a vehicle for work. Set emergency brake and use tire blocks. Locate and use the vehicle manufacturers designated lifting points. Use jack stands.
- Always use appropriate and adequate care in lifting components into place.
- Always ensure components will remain secure during installation and operation.
- Always wear safety glasses when installing this kit. A drilling operation will cause flying metal chips. Flying chips can cause serious eye injury.
- Always use extreme caution when drilling a vehicle. Always disconnect power before welding. Thoroughly inspect the area to be drilled (on both sides of material when possible) prior to drilling, and relocate any objects that may be damaged.
- Always use extreme caution when welding a vehicle. Thoroughly inspect the area to be welded (on both sides of material when possible) prior to welding, and relocate any objects that may be a fire hazard. When welding in a cab, make sure the interior surfaces are covered (e.g., welding blanket) and a fire extinguisher is at hand.
- Always use extreme caution when cutting and trimming during fitting.
- Always tighten all nuts and bolts securely per installation instructions.
- Always route electrical cables carefully. Avoid moving parts, components that become hot, and rough or sharp edges.
- Always insulate and protect all exposed wiring and electrical terminals.
- Perform regular inspections and maintenance on mounts and hardware.

TABLE OF CONTENTS

2	SAFETY / DISCLAIMER
3	TABLE OF CONTENTS
4	A MESSAGE FROM THE OWNER
5	GETTING STARTED
6	PROVIDED MATERIAL
7	DISASSEMBLY
9	INSTALLATION
25	CONTACT

A MESSAGE FROM THE OWNER



Fab Fours' was born out of a passion for customizing vehicles and a love of the outdoors. Our engineering team uses the latest 3D design software to turn new product ideas into reality. In our factory, designs come to life with the combination of cutting edge technology for metal cutting and forming and an American workforce that puts its' heart and pride into every product.

From design and manufacturing, to quality and delivery, Fab Fours' mission is to be the market leader for steel truck and jeep accessories. We make sure a quality product is delivered on time, more than expected, better than expected to our customers.

Enjoy your new Fab Fours product. Welcome to the family!

Greg Higgs

FOUNDER, FAB FOURS

GETTING STARTED

Before you begin the installation process of your new Fab Fours product, we suggest laying out all materials and parts on a pad or protective surface.

Failure to fully account for all components before beginning installation may leave vehicle immobile until part is acquired. Refer to the next pages as an inventory check.

PROVIDED MATERIALS

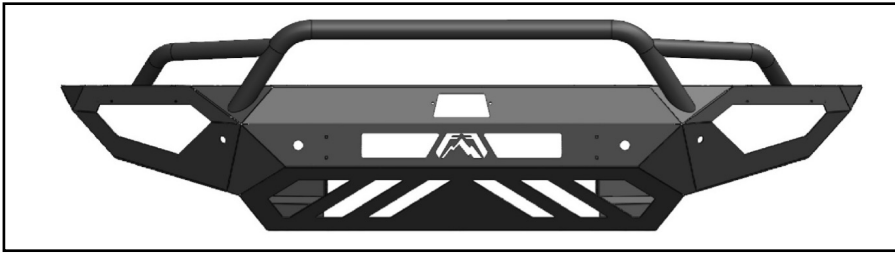

22609 - FAB FOURS VENGEANCE BUMPER

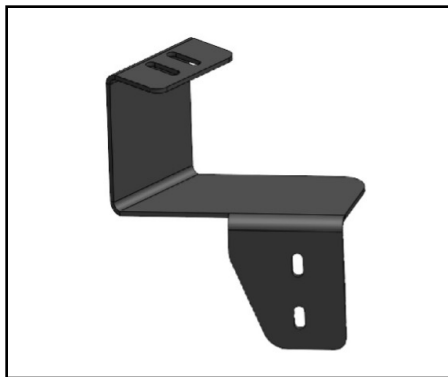

22610 - AIR DAM
RELOCATION BRACKET



22352 - LIGHT BAR
L-BRACKETS

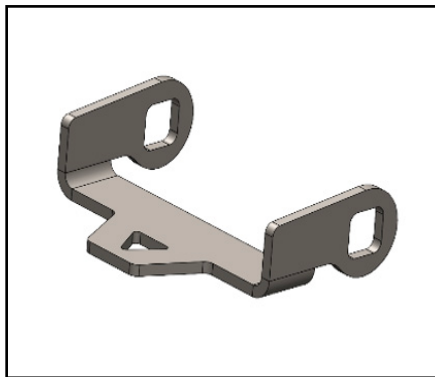

22840 - AIR DAM MOTOR
ARM REPLACEMENT



61784 -
ADAPTIVE CRUISE
CONTROL
PLASTIC COVER

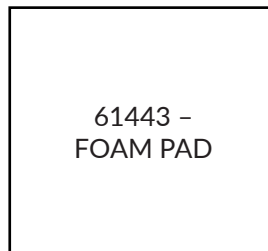

61443 -
FOAM PAD

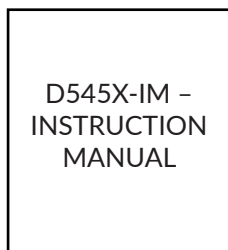

D545X-IM -
INSTRUCTION
MANUAL

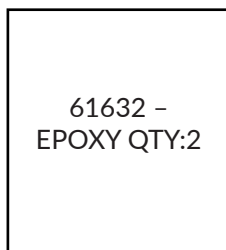

61632 -
EPOXY QTY:2



50315-HM -
HARDWARE
KIT

TOOLS REQUIRED

- 7mm
- 10mm
- 17mm
- 3/8"
- 7/16"
- 1/2"
- 5/8"
- Phillips Head Screw Driver
- Body Pry Tool
- Cutting Tool
- Masking Tape
- Measuring Tool

ASSISTANCE

We recommend two people perform the installation as items are heavy and may need to be held in place while installing.

ORGANIZATION

Disassemble the vehicle where you can catalog and store everything. We suggest labeling and bagging all the OEM bolts when removing from the vehicle. Failure to keep track of parts could lead to an inability to properly reinstall components.

ASSISTANCE

This manual shows the six sensor configuration for illustration purposes but your specific installation may vary.

HARDWARE KIT | D545X-IM

FAB FOURS IDENTIFICATION	COMPONENT DESCRIPTION	QTY
50313-HW	10-24 X 3/4", Black Button Head Bolt 18/8SS	2
50313-HW	10-24 Hex Nut 18/8SS	2
50313-HW	#10 Lock Washer 18/8SS	2
50313-HW	#10 Flat Washer 18/8SS	2
50313-HW	1/4"-20 x 1", Yellow Zinc Hex Bolt, Grade 8	6
50313-HW	1/4"-20, Yellow Zinc Hex Nut, Grade 8	6
50313-HW	1/4" Yellow Zinc Flat Washer, Grade 8	12
50313-HW	1/4" Yellow Zinc Lock Washer	6
50313-HW	7/16"-14 x 1.5", Yellow Zinc Hex Bolt, Grade 8	4
50313-HW	7/16" Yellow Zinc Flat Washer, Grade 8	8
50313-HW	7/16" Yellow Zinc Lock Washer, Grade 8	4
50313-HW	3/4" Plastic Sensor Plug	2
50313-HW	1" Plastic Sensor Plug	2

1. Use 3/4" masking tape to create a cutting line on the front valance. Use the outer body line to line up the lower portion of the tape. Figure 1-2.

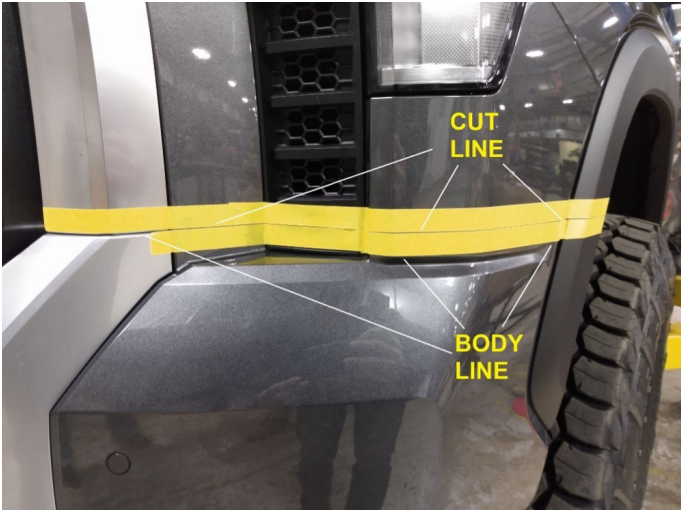

Figure 1

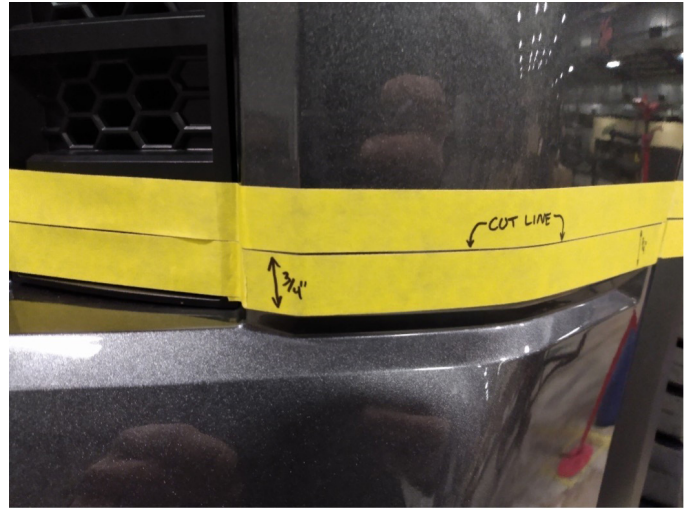

Figure 2

2. Line the tape from the grill bodyline to the valance measure at a measurement of 7/8" from the mesh deck. Figure 3.



Figure 3

3. Use a razor blade to cut the tape on the mesh piece. Carefully use a body pry tool to separate the mesh from the front valance. Figure 4.



Figure 4

4. Once the tape cutting line is in place, carefully use a cutting tool of choice to cut along the line all the way through the fender flare. Figure 5.



Figure 5

5. Use the cutting tool to cut the mesh insert. Figure 6.



Figure 6

6. Use a 10mm socket to remove the 4x bolts holding the top of the grille to the radiator frame (Figure 7.). Use a body pry tool to remove the 2x push pins on the sides of the top grill and unplug the wiring harness (Figure 8.).



Figure 7



Figure 8

7. Use a 10mm socket to remove the 4x bolts on the front of the wheel wells to access the valance body clips.
Figure 9.



Figure 9

8. Carefully use a body pry tool to disengage the panel clips holding the fender flare onto the truck. Pull the flare away from the body to access the valance clips. Note: Do NOT fully remove fender flare. Figure 10.

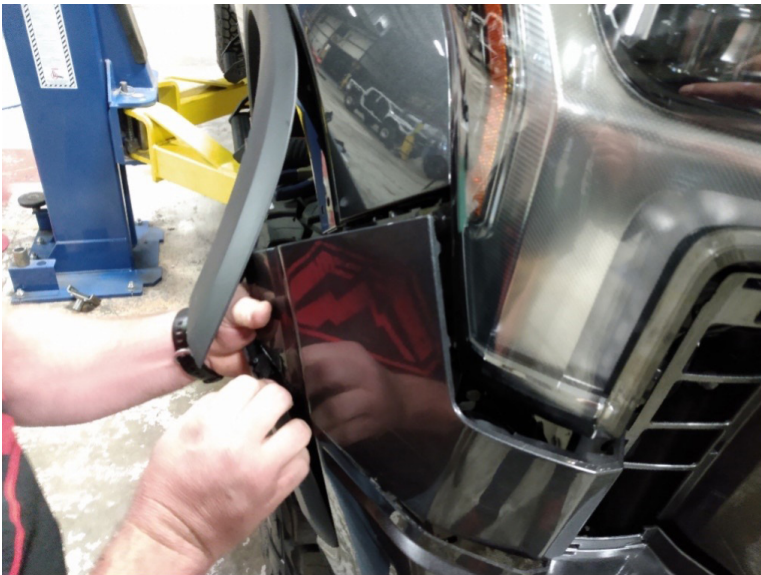

Figure 10

9. Use a 10mm socket to remove the 4x bolts holding the bottom of the bumper to the frame structure.
Figure 11.



Figure 11

10. Remove the grill and bumper assembly from the truck by carefully disengaging the lower grille panel clips. Set the grill assembly aside for disassembly.

11. Use a 17mm socket to remove the 8x bolts (2x on top 2x on bottom) holding the crash bar to the frame rails. Figure 12-13.



Figure 12

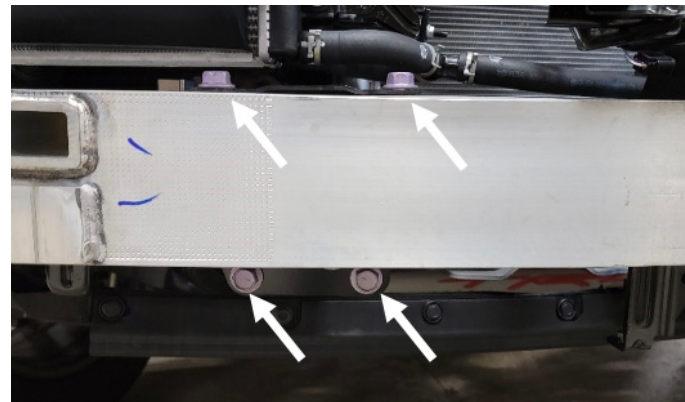

Figure 13

12. Start disassembling the grille by remove the sensors and sensor housings form the bumper. remove the sensor from the housing by disengaging the top clips and carefully pulling the sensor out. Figure 14.

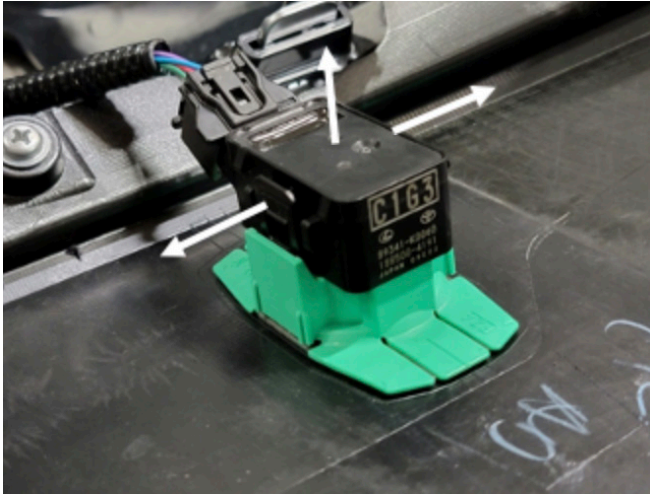

Figure 14

13. Use a Phillips head screw to remove the 4x bolts holding the lower bumper pieces onto the grille assembly. Figure 15.



Figure 15

14. Remove the lower grille cover (Figure 16) by removing 2x Phillips head screws and disengaging 7x body clips. Figure 16-18.



Figure 16



Figure 17



Figure 18

15. Remove the fog light cover panel (Figure 19) by disengaging the 17x body clips. Figure 19-20.



Figure 19

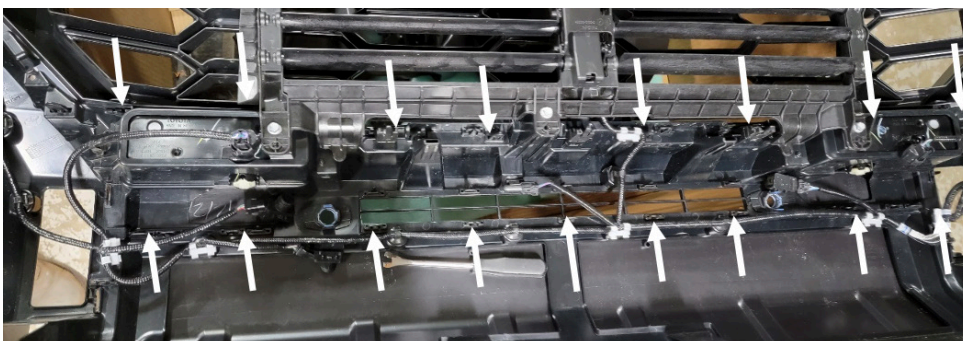

Figure 20

16. Use a Phillips head screwdriver to remove the 2x bolts holding the fog lights to the grille assembly. Figure 21.



Figure 21

17. Use a body pry tool to remove the wiring harness from the lower bumper. Note: Leave the harness attached to the grille. Figure 22.

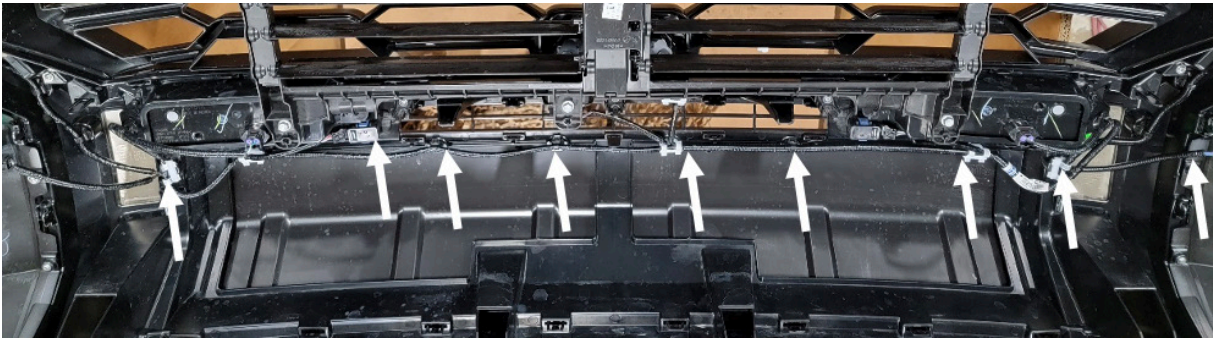

Figure 22

18. Cut the lower portion of the grille off using the lines shown in Figure 23-24.



Figure 23



Figure 24

19. Reinstall the grille assembly by reversing steps 6-8. Figure 25.



Figure 25

20. Use a Phillips head screwdriver to remove the bolts on the air dam housing. Figure 26.

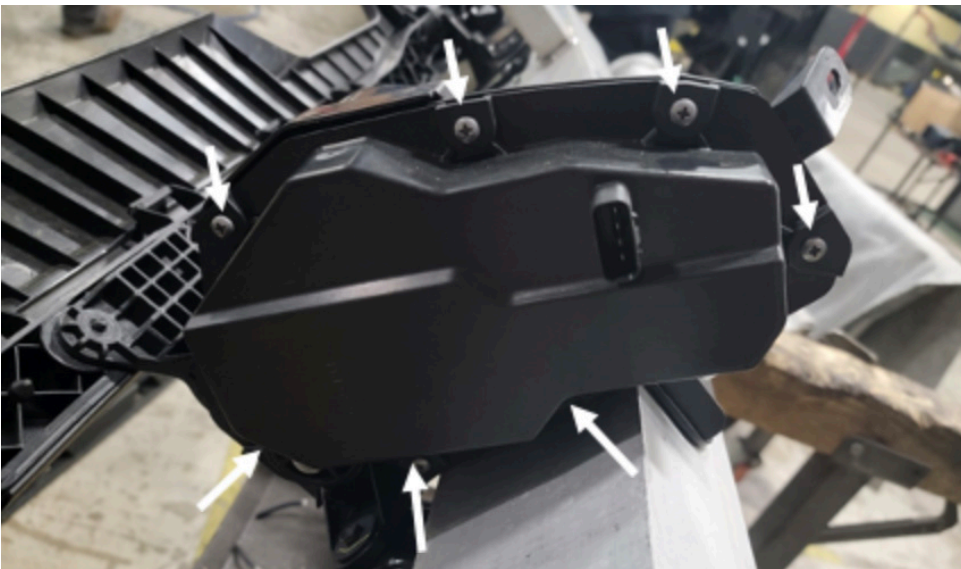

Figure 26

21. Use a 10mm socket and a Phillips head to remove the 2x hex head bolts and 1x screw respectively. Remove the motor assembly from the housing. Remove the motor assembly from the aluminum crash bar using a 10mm socket to remove the 4x bolts. Figure 27.

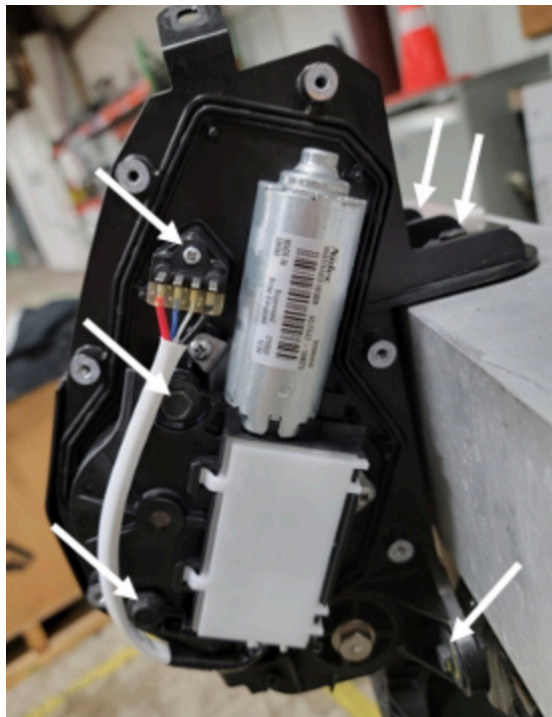

Figure 27

22. Remove the white plastic gear from the motor assembly by pulling it off. Figure 28.

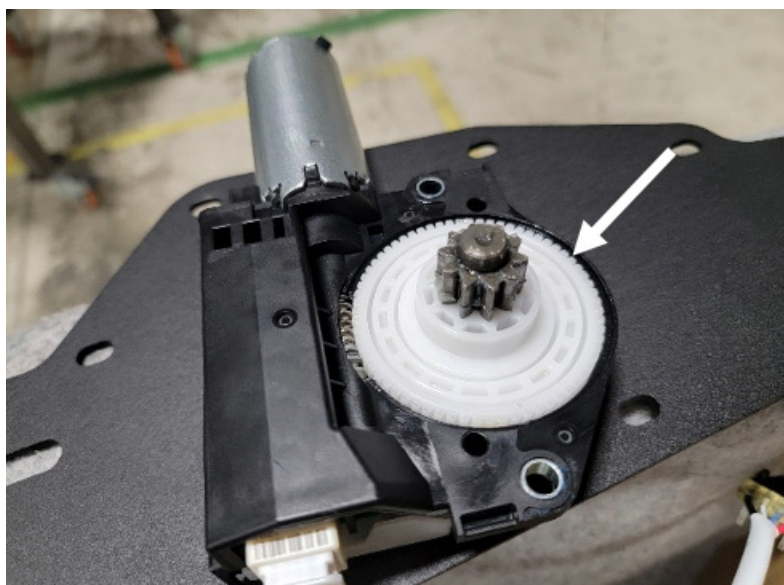

Figure 28

23. Use a Phillips head to remove the 3x bolts holding the gear and shaft in place. Remove the gear and shaft from the assembly. Figure 29-30.



Figure 29



Figure 30

24. Remove the E-clip from the linkage pin. Set the gear shaft linkage aside for later assembly. Figure 31.



Figure 31

25. Use a cutting tool to remove the access gusset material on the air dam motor housing. Figure 32-36.

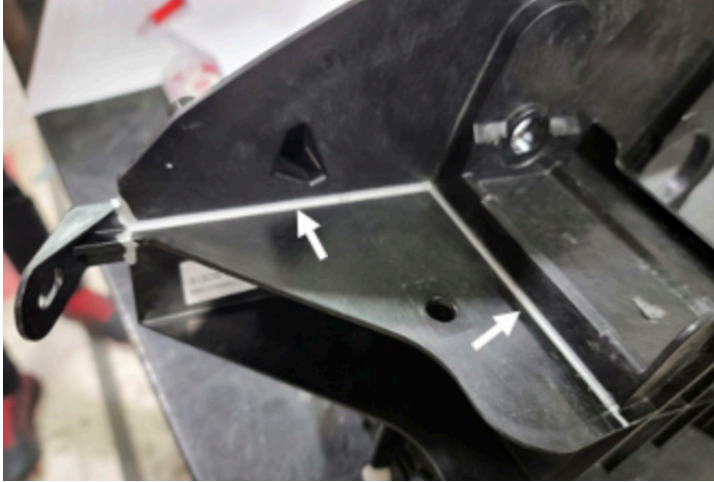

Figure 32



Figure 33

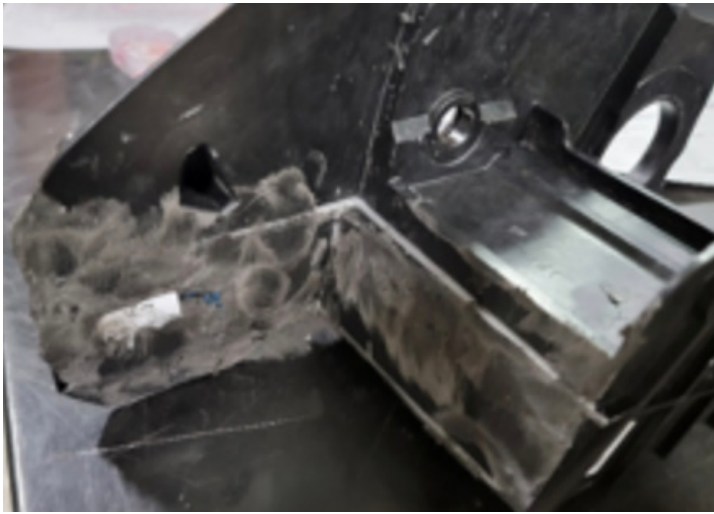

Figure 34

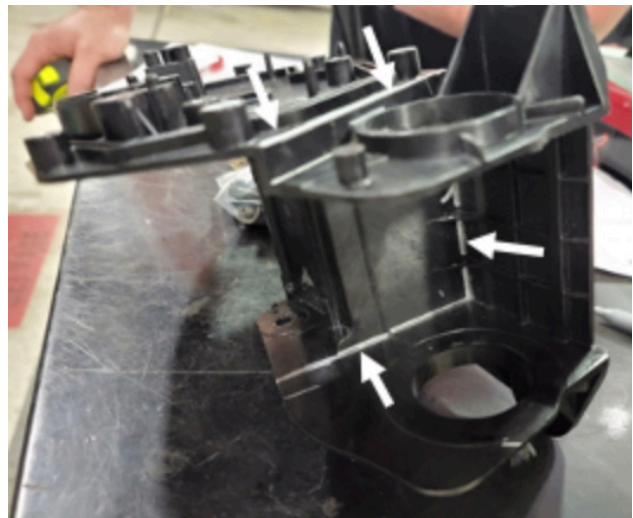

Figure 35



Figure 36

26. Begin reassembling motor by replacing arm linkage (removed in step 24) with arm replacement 22840. Figure 37.



Figure 37

27. Reverse steps 20-23 to put the motor assembly back together. Include the shaft linkage removed in step 24.

28. Use a 1/4" drill bit to drill 2x holes in the motor assembly to attach it to the provided mounting bracket (22610). Use the provided 1/4" yellow zinc bolts with washers and nuts. Figure 38.



Figure 38

29. Use a 12mm and 10mm socket to relocate the passenger side horn to the 10mm bolt. This will allow room for the air dam relocation. Figure 39-40.

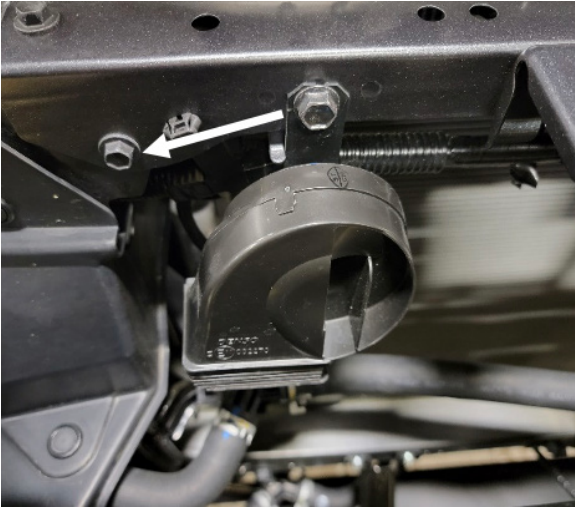

Figure 39

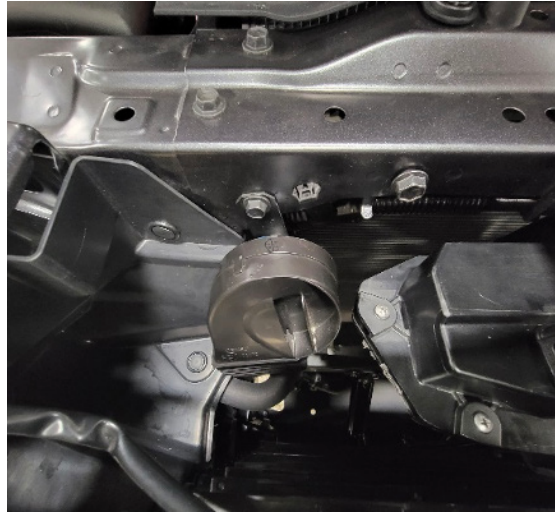

Figure 40

30. Use the provided ¼" yellow zinc bolts with washers and nuts to attach the air dam relocation bracket to the grill mounts. Plug in the air dam motor to its harness. Figure 41.

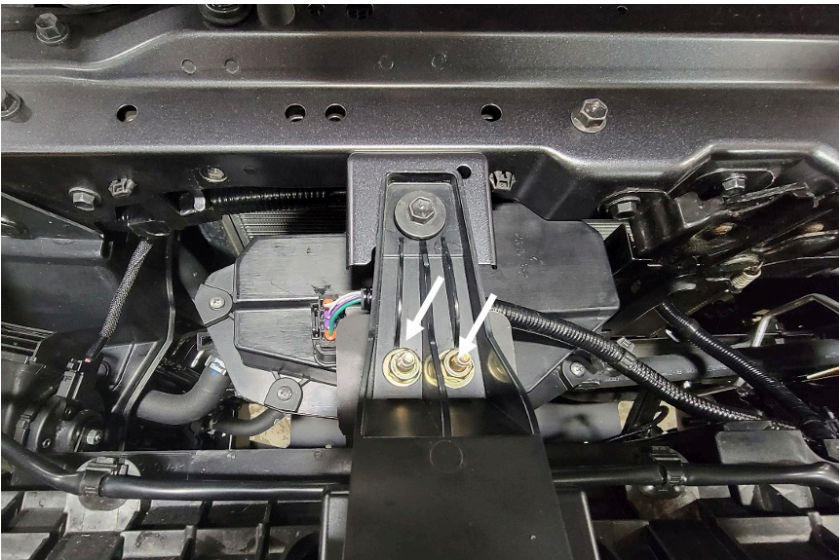

Figure 41

31. Cut the provided plastic sheet to fit the top bumper cut out. This will allow the Adaptive Cruise Control sensor to see through the Fab Fours bumper. Use the provided #10 stainless steel black anodized bolts with washers and nuts to attach the plastic to the bumper. Figure 42-43.



Figure 42



Figure 43

32. If installing a light bar: Use the provided L brackets (22352) along with 2x 1/4" bolts with washers and nuts to position the light bar in place. Figure 44.



Figure 44

33. Remove the sensor housing from the OEM bumper by carefully using a pry tool or razor blade to separate the 3M adhesive from the shell. Figure 45.

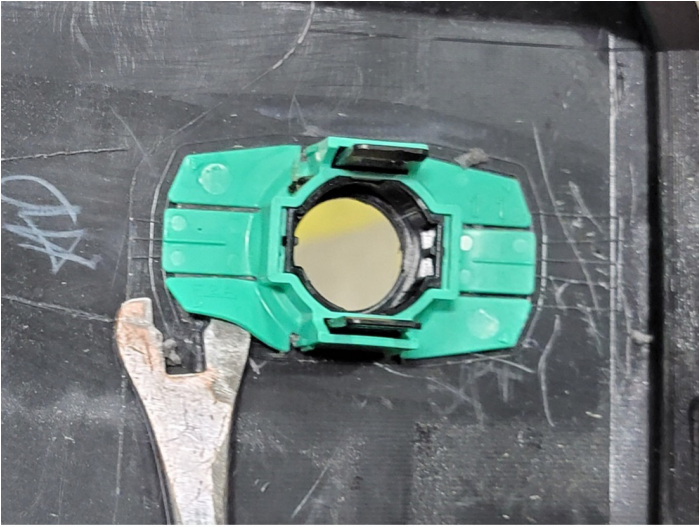

Figure 45

34. Use the provided epoxy packets to attach the sensor housings into your Fab Fours bumper. Place a small dap of epoxy under both corners of the housings and press it into the shell. Use duct tape to hold it in place until the epoxy is dry. Figure 46.

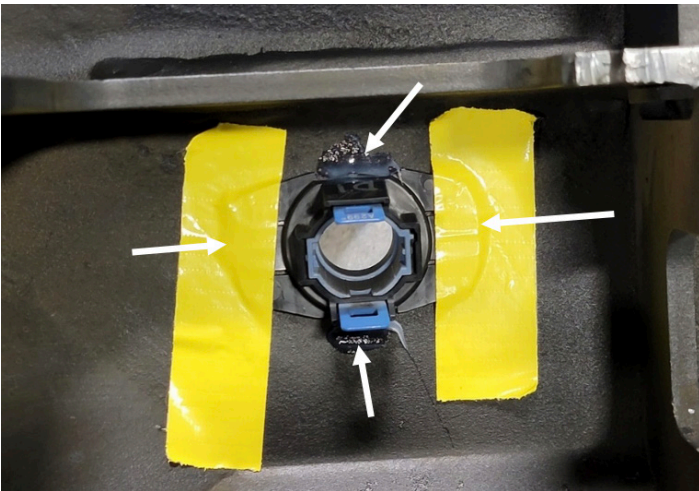

Figure 46

35. With assistance, hold the bumper up to the frame and use the provided 4x 7/16" yellow zinc bolts with washers, along with 4x of the OEM frame bolts removed in step 11 with washers to attach it. Figure 47-48.

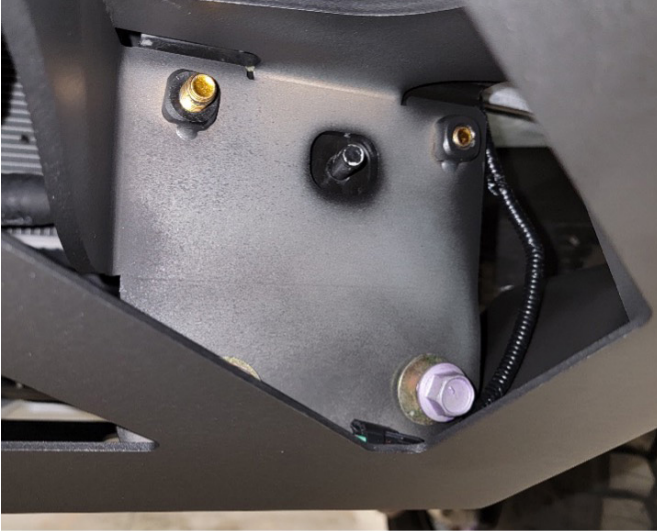

Figure 47



Figure 48

35. Tighten all mounting hardware and plug in sensor harness.

CONTACT INFORMATION

**FAB FOURS INC.
2213 INDUSTRIAL PARK ROAD
LANCASTER, SC 29720**

PHONE: (866) 385-1905

FAX: 970-385-1914

EMAIL: SUPPORT@FABFOURS.COM

FABFOURS.COM



**“IF YOU’RE LOOKING FOR MORE OF THE SAME,
THEN YOU’VE COME TO THE WRONG PLACE.”**

- GREG HIGGS

